

HG-303555-2687, HG-303551-2688

Parts List

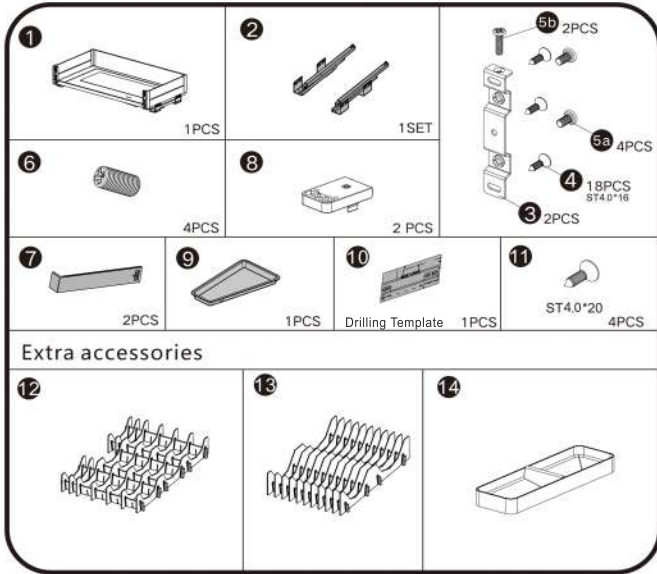

Note:
Cabinet height 210mm is the minimum height for installation.
Larger heights can still be accommodated as long as W stays the same.

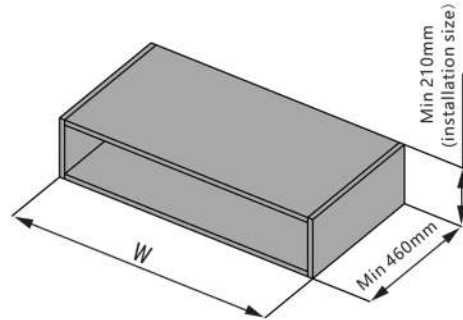

Accessory quantity and dimension according to cabinet width:

Cabinet width (W)	Acces. 12	Acces. 13	Acces. 14
900mm	277mm	277mm	2
600mm	177mm	177mm	1

STEP 1. Installation of runners

Affix the **2** rail runners into the internal walls of the cabinet.

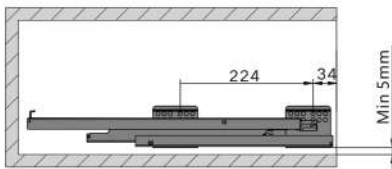
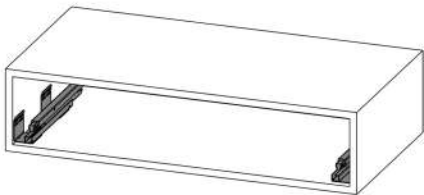

STEP 2. Installation of runners lock

Affix the **8** rail runner lock into the bottom of **1** basket using **11** 4pcs of ST4*20 screws.

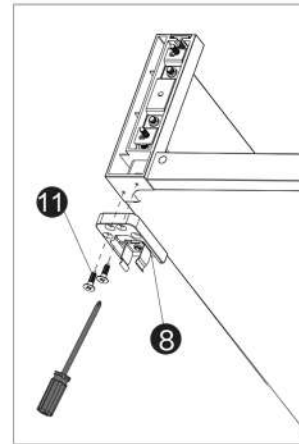

STEP 3. Installation of basket

Align the basket to the runners mounted to the cabinet.

Ensure that the bottom fastener clasps properly into the runners.

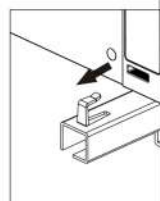
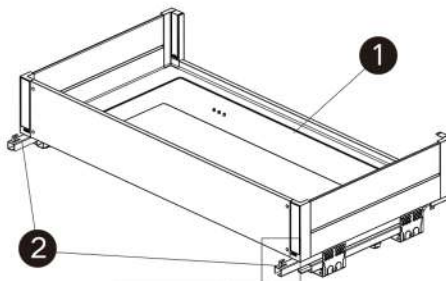

A. Basket holes buckle with slider back hooks

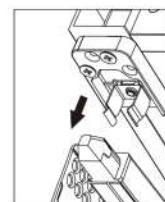
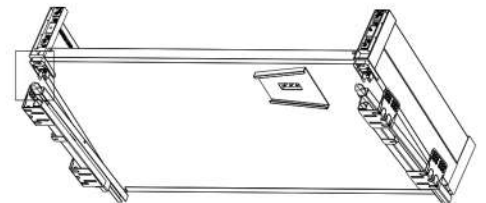

B. Bottom fasteners clasp to the slider front

STEP 4. Installation of drain tray

Slide the **9** drain tray into the slot underneath the basket.

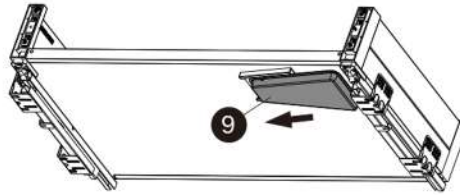

STEP 5. Installation of door panel

Pre-drill 2.5mm holes on the door panel as illustrated. Then affix the **3** door fixings using the **4** **5a** **5b** provided screws.

Attach the basket to the door panel. Adjust the door so it aligns to the cabinet. Once secured with **6** 4pcs of screws, place the **7** decorative covers to conceal the screw work.

Pre-drilling guide

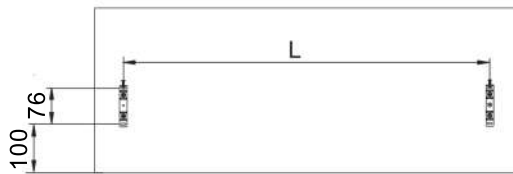

W	900	600
L	778	478

Door fixing installation

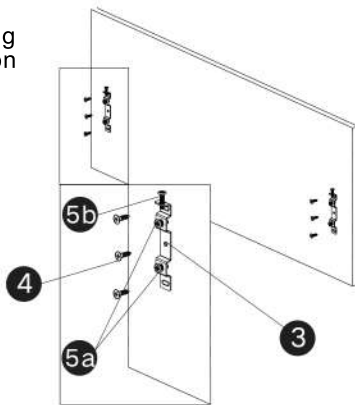

Top screws installation

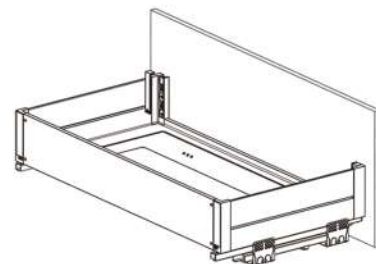
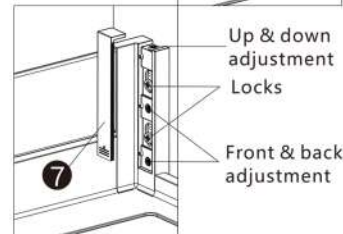
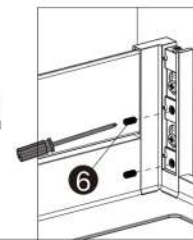

STEP 6. Installation of accessories

Place the **14** cutlery trays and **12** **13** dish stands in the drawer basket as shown.

